

# Red Valve

THE WORLD LEADER IN PINCH VALVE TECHNOLOGY  
*Condensed Catalog*

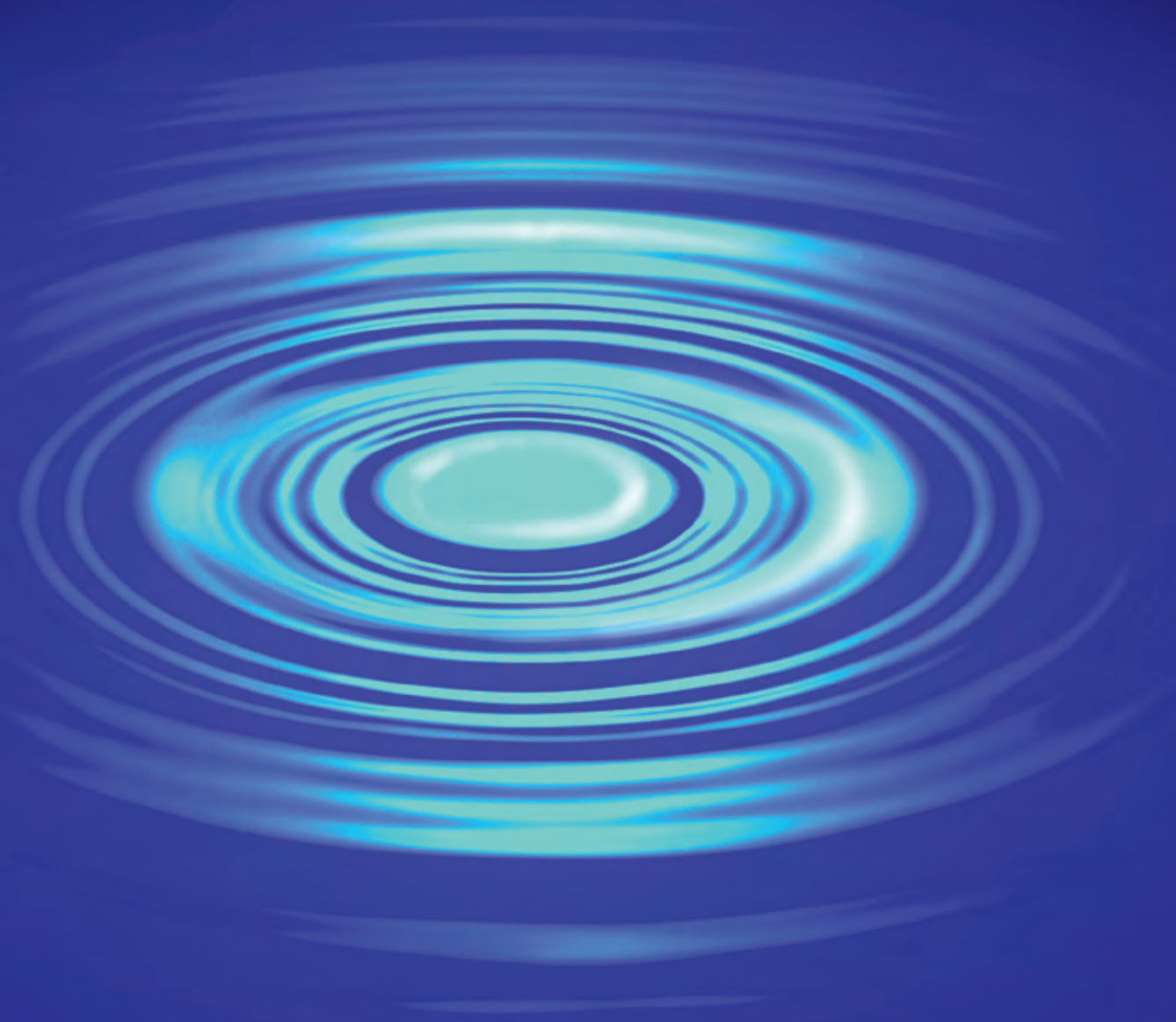

# Red Valve: The Best Choice for the Toughest Applications

*Red Valve's corporate headquarters in Pittsburgh, PA*



## **A Worldwide Customer Service Network**

*Red Valve offers a worldwide, world-class customer service network. With manufacturing plants in Charlotte, NC, and Pittsburgh, PA, and sales representatives in 175 cities in 75 countries around the globe, Red Valve has the sales engineering team to help you select the best choice of valves and related products for your applications.*

*Right: Red Valve's legendary Type A Pinch Valve was invented and patented in 1953 for the world's first coal slurry pipeline.*

**Solving your most demanding flow control applications — this has been the single, driving force behind Red Valve since our founding in 1953. Today we remain dedicated to responding to your needs with valve products and engineering services that set the standard for the world's toughest applications. Our initial order was for the world's first coal slurry pipeline, where we created the only available valve capable of reliable slurry control. Today, Red Valve is the world's largest manufacturer and supplier of pinch valves and has become the preferred supplier for municipalities and industrial plants worldwide. Red Valve's global representative network stands ready to work with you to solve your toughest applications.**

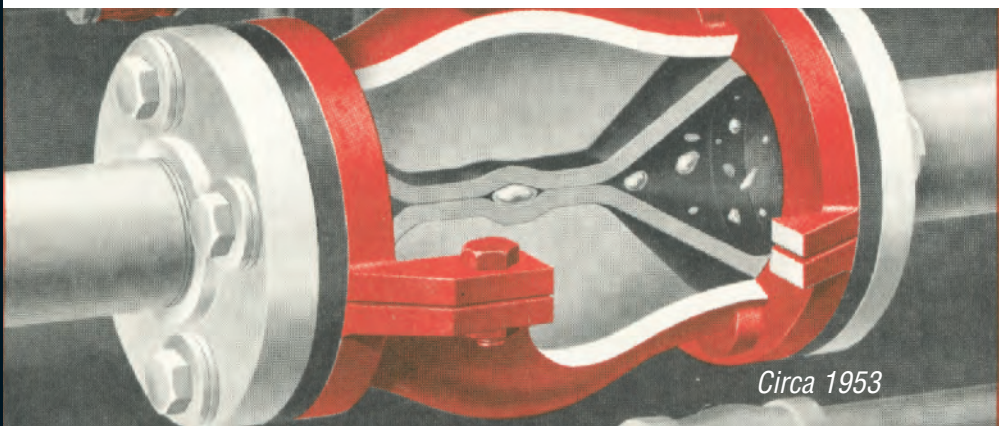

*Circa 1953*

# Red Valve: Providing Cost-Effective, Creative Valve Solutions

## New Curved Bill Tideflex®

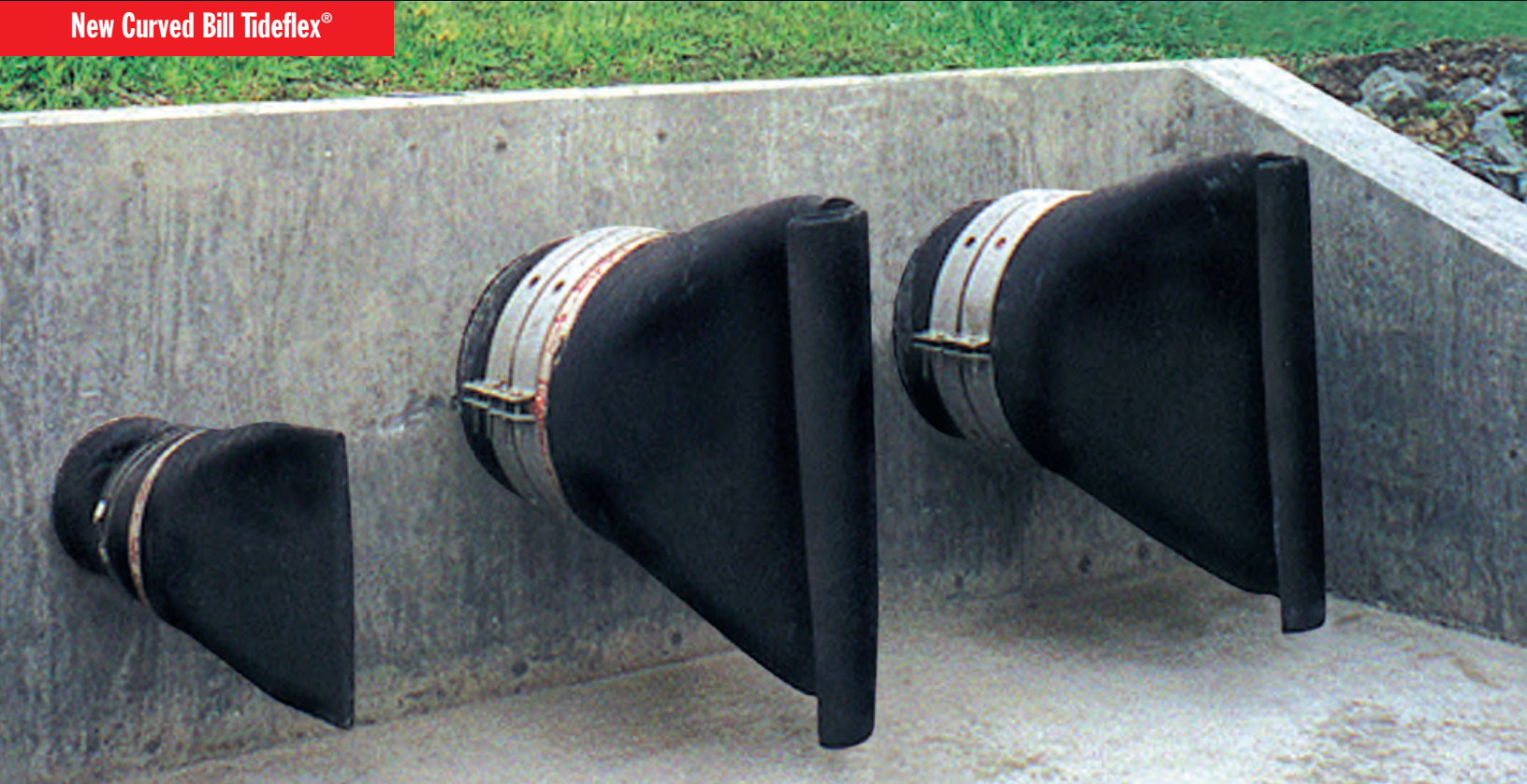

## Influent Flow Control Valve



*Above: The new Curved Bill Tideflex® uses the same construction as the traditional Tideflex® Check Valve but has a 180-degree curve that allows the valve to form a tighter seal around solids common in stormwater, effluent and CSO outfalls.*

*Left: Red Valve's large-diameter influent flow control valves are ideal for wastewater treatment plants. Benefits include a full-port, no-hang-up design and accurate control.*



Mr. Spiros G. Raftis, founder of Red Valve Company

## Pinch Valves



*Designed for slurry and abrasive and corrosive chemical applications, Series 70 and 75 Manual Pinch Valves provide reliable, bi-directional shutoff with an ANSI B16.10 face-to-face.*



## Control Valves

*Red Valve's 5200E Electrically Actuated Control Valve provides economical, reliable and precise control.*



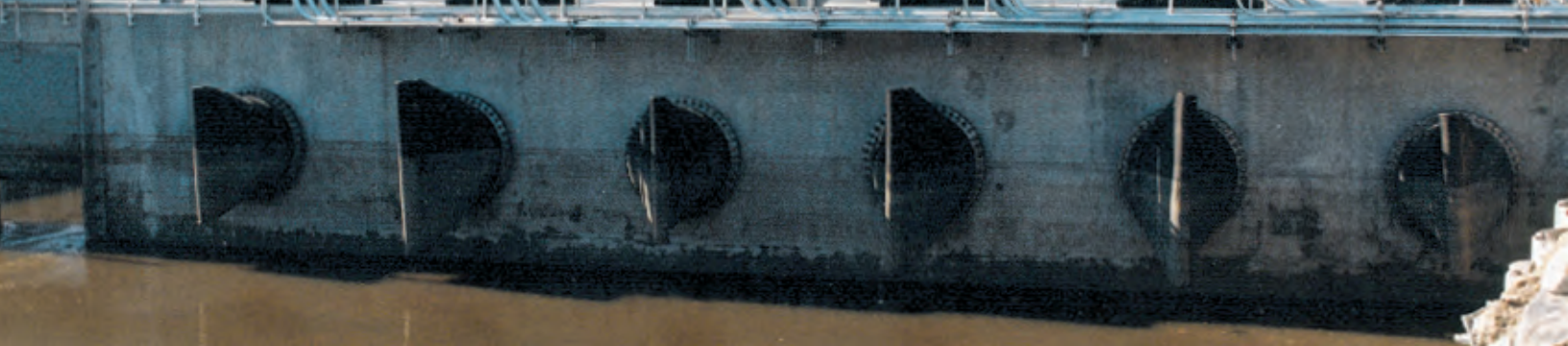

Red Valve Company is the world's largest manufacturer of pinch valves and has an international reputation for quality-engineered valves designed for long life in the toughest municipal and industrial applications. Red Valve's advanced elastomer technology is engineered into every Red Valve pinch valve, control valve, slurry knife gate valve, pressure sensor, Redflex® Expansion Joint and revolutionary all-rubber Tideflex® Check Valve. We're dedicated to listening and responding to customer needs with innovative products and services.

## Red Valve products manage the toughest flow applications in:

- ▶ **Wastewater treatment plants:**  
Sludge handling, grit removal, raw sewage, lime, carbon slurry
- ▶ **Power plants:**  
FGD systems, scrubber systems, coal handling
- ▶ **Mining:**  
Tailings, flotation control, thickener underflow lines, numerous other slurry applications
- ▶ **Chemical processes:**  
Corrosive and abrasive materials, powders, pellets

Many other operations, such as pulp and paper mills, the electronics industry, food industry, cement, sand, glass and industrial treatment plants, present difficult challenges for which Red Valve products are well suited.



**Tideflex® Coarse Bubble Diffuser**



### Air-Operated Pinch Valves

First introduced by Red Valve, the Type A Miniflex and Megaflex are the most economical large- and small-diameter automatic valves on the market today.

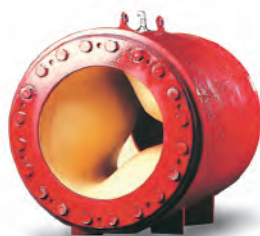

### Pressure Sensors

Providing a full 360° pressure reading, Red Valve pressure sensors are the industry standard for protecting instrumentation and ensuring accurate, dependable pressure measurement.



*Red Valve's Series 5200 Control Valve – offering maximum durability with precise control – eliminates costly maintenance problems.*

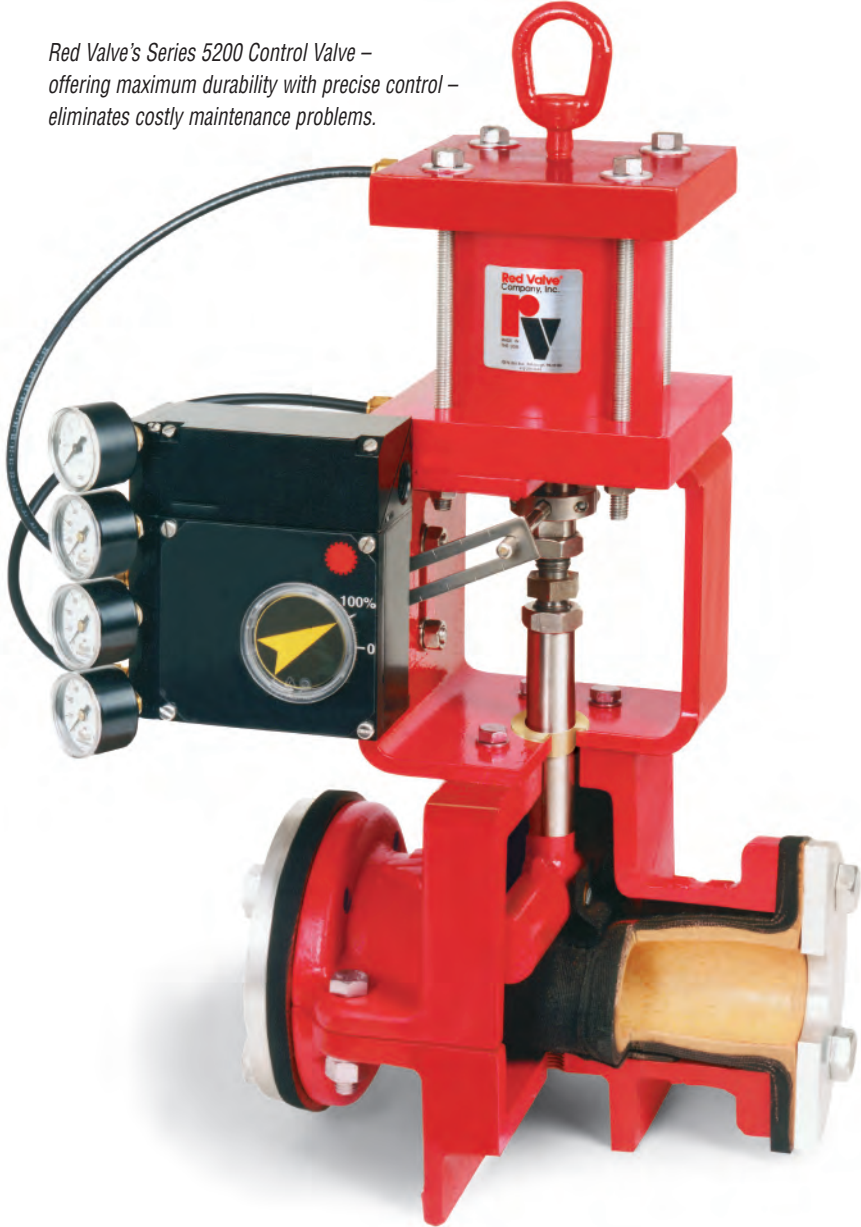

*The Series 9000 High-Pressure Pinch Valve is Red Valve's ANSI Class 300 control valve product. Offering working pressures up to 720 psi, the valve is designed for a variety of on/off and control applications.*



**Redflex® Expansion Joints**

*Red Valve's complete line of Redflex® expansion products includes expansion joints in a variety of styles and materials.*



**Flexgate Valves**

*Providing a bi-directional, drop-tight shutoff, Red Valve's Flexgate Valve is designed with a stainless steel gate and two heavy-duty elastomer cartridge slurry seats – ideal for difficult abrasive slurry applications.*

# Pinch Valve Sleeves

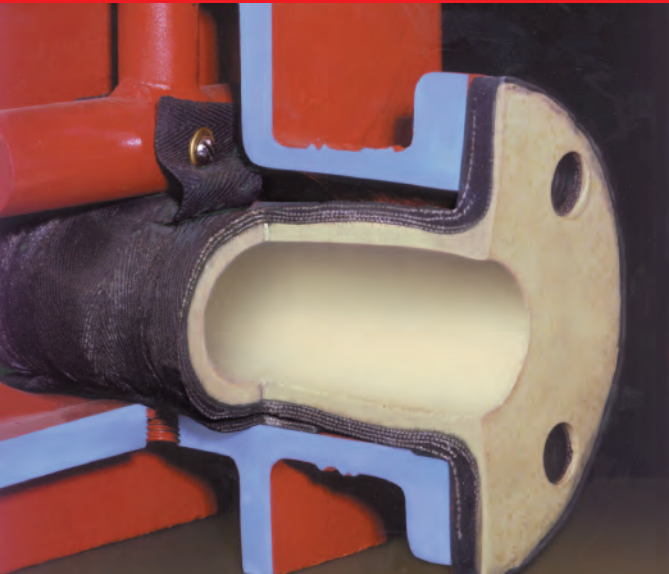

- ▶ Full face-to-face integral elastomer molded flange
- ▶ Manufactured to the highest standards
- ▶ Superior service life
- ▶ Full-port, double-wall or cone sleeve trim
- ▶ Sleeves available in a wide variety of elastomers
- ▶ Custom sizes available

4

## Pinch Valves Outlast Traditional Alloy Valves

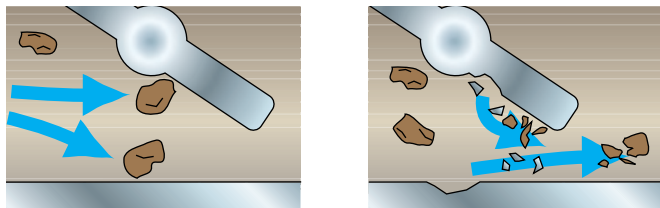

*When abrasive particles strike the hard surface of traditional metal valves, the energy of the impact is completely absorbed by the metal surface, prematurely wearing seats, weirs, rotating discs, plugs and balls. Additionally, these abrasive particles pack behind the ball and plug, scoring the sealing surface and creating leaks.*

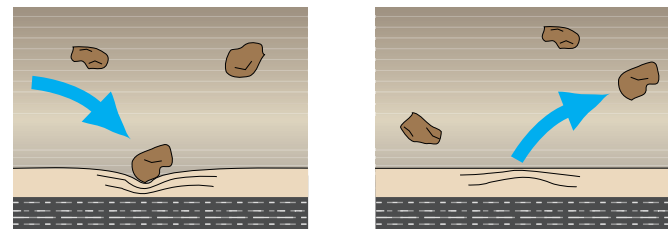

*When abrasive particles strike elastomer surfaces, the impact is absorbed, then deflected back into the particle. Extremely resilient elastomers wear at a far slower rate than ceramics or metal alloy valve trims. Pinch valves are full-ported with no crevices, packing glands or seats to foul valve operation.*

**T**he most important part of any pinch valve is the sleeve. The pinch sleeve is truly the “heart” of the pinch valve, providing corrosion resistance, abrasion resistance and pressure containment. The quality of a pinch valve rests in the quality of its sleeve.

## World-Class Supplier

Red Valve Company, Inc. has been manufacturing sleeves since 1953, using only the best materials from world-class suppliers, such as E.I. DuPont de Nemours, Firestone and Goodyear. Red Valve incorporates the best technology in elastomer compounding and synthetic materials, which results in our customers having trouble-free, high wear-resistant pinch valve sleeves that outperform and outlast all other designs. Reground or recycled materials are never used in Red Valve products.

## Low-Maintenance Design

Red Valve’s pinch valves are designed specifically for low-maintenance. The sleeve is the only replacement part required for a pinch valve. There are no seats, packing, seals, or bellows to routinely replace. Once a sleeve is replaced, the valve is like new again. There is little need to inventory other valve parts.

## Elastomer Selection

- ▶ Pure Gum Rubber
- ▶ Viton®
- ▶ Neoprene
- ▶ Hypalon®
- ▶ EPDM
- ▶ Chlorobutyl
- ▶ Buna-N
- ▶ Food-grade materials

# Sleeve Trim Selection

**Standard Sleeves**, provided by Red Valve, are very specialized components. Great care is taken to match the type of elastomer, pressure rating, and temperature limits to the customer's needs. This ensures a long and maintenance-free service life. The full port of the standard sleeve provides uninterrupted flow just like another piece of pipe, and the flow remains streamlined when throttled.

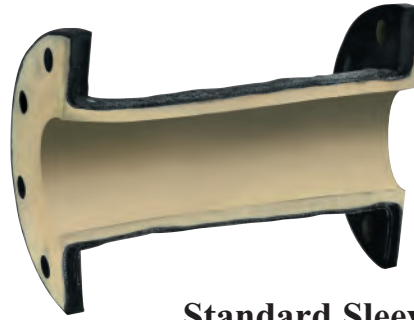

**Standard Sleeve**

**Cone Sleeves**, patented by Red Valve, are designed for control applications. Cone sleeves provide tighter control with a 20:1 turndown ratio and 0.89 pressure recovery factor, along with an extra thickness of elastomer on the downstream side of the cone to increase its service life.



**Cone Sleeve\***

**Double Wall Sleeves** are designed for extremely abrasive slurries. The double wall sleeve has triple the thickness of elastomer than Standard Sleeve. The next larger valve size must be used with the double wall to maintain a full port due to the additional thickness of the sleeve.



**Double Wall Sleeve**

**High Pressure Sleeves** are designed for high pressure ANSI 300 applications up to 720 psi. The high-pressure sleeve features stronger fabric reinforcement and thicker construction compared to a standard sleeve. The face flanges are equipped with integrated o-ring seals to ensure a tight seal under high-pressure applications.



**High Pressure Sleeve**

*\*Patented*

## The Best Choice



*The pinch valve's flexible, full-port sleeve contains no crevices or dead spots.*



*This feature eliminates turbulence and wear, provides a smooth closing venturi, and self-cleans with each operation.*



*Fully closed, the pinch valve ensures a droptight, bi-directional shutoff and an intrinsically safe design with no packing to maintain.*

### Cone Sleeve Advantages

*Cone sleeve trim provides tighter control with a 20:1 turndown ratio and 0.89 recovery factor. Pressure recovery occurs downstream of the sleeve, so cone sleeves can handle a higher pressure drop than other sleeve designs.*



# Type A Pinch Valve

- ▶ Closes drop-tight on entrapped solids
- ▶ Body functions as built-in actuator
- ▶ No cavities or dead spots to bind valve operation
- ▶ Full-port, double-wall or cone sleeve trim
- ▶ Simple design not affected by harsh external environments
- ▶ No packing to replace or maintain, ever
- ▶ Cost effective, maintenance free

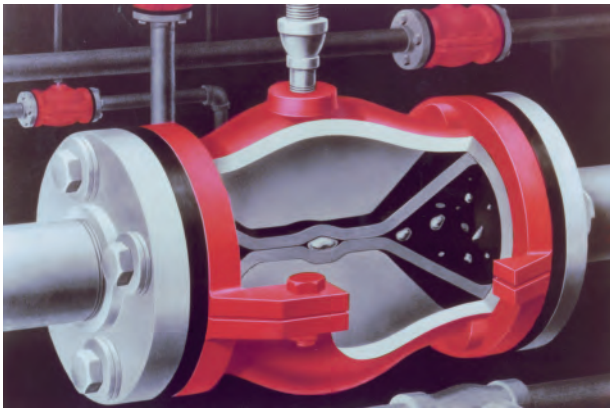

6

## Materials of Construction

- ▶ Cast iron or aluminum body
- ▶ Sleeves available in Pure Gum Rubber, Neoprene, Hypalon®, Chlorobutyl, Buna-N, EPDM and Viton®
- ▶ ANSI Class 125/150, 250/300

## Controlling a Type A with a Proportional Relay

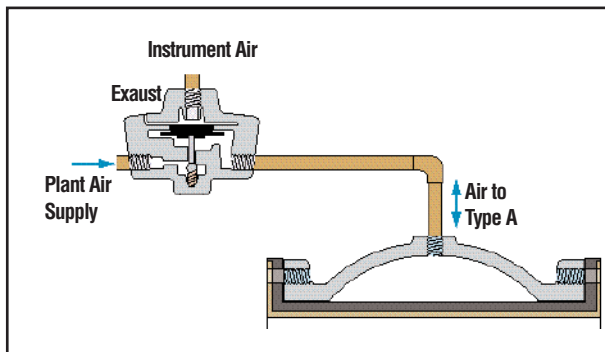

Red Valve recommends an adjustable relay (as opposed to a fixed, proportional relay).

Introduced and patented by Red Valve, the air-actuated Type A Pinch Valve offers a unique, cost-effective solution to flow control problems. More Red Valve Type A Valves are in use than any other pinch valve throughout the world. The secret is in the rubber sleeve – the valve's only wetted part.

Actuation of the valve, the pinching action, is accomplished by air or hydraulic pressure placed on the sleeve. The valve body acts as a **built-in actuator**, eliminating costly pneumatic, hydraulic or electric actuators. Modulating the air pressure within the annular space between the body and the sleeve can open, throttle or close the valve. Approximately 35 psi over line pressure is required for closure.

The sleeve's flexibility allows the valve to close drop-tight around entrapped solids, eliminating hang-ups that could damage the valve. The sealing area is equal to 95 percent of the valve's length. There are no seats or packing to replace and no cavities or dead spots to collect debris and bind valve operation. The Type A Valve's abrasion resistance is unmatched. When the valve is open, it operates like a straight piece of pipe in the line. Type A Valves are used on remote locations or harsh environments since there are no external links, levers, pistons or rotating parts to cause downtime.

## Control

Throttling control is accomplished by using a booster or proportional relay to modulate air pressure to the Type A Valve. A changing air signal through the proportional relay will modulate the Type A Valve.

## Type A Double Wall

Designed for highly abrasive applications, the Type A Double-Wall Sleeve Valve outlasts even stellited V-Ball valves and metal-seated valves on abrasive slurries. To compensate for the extra sleeve thickness, the valve body is increased to the next size.

## Type A Cone

Type A Cone Sleeve Valves are designed specifically for throttling control applications. The Cv of the valve can be matched to any requirement by reducing the port at the center of the sleeve. The port reduction is maintained through the downstream half of the sleeve for increased wear resistance, and because pressure recovery occurs downstream of the valve, cavitation is minimized.



## Type A – Full Port

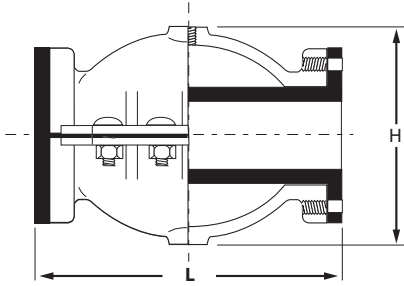

VALVE SIZE	LENGTH L	HEIGHT H	WORKING PRESSURE psi	WEIGHT CAST IRON lbs	AIR VOLUME ft <sup>3</sup>	AIR INLET NPT
1/2"	3"	3-1/2"	150	5	.002	1/4"
3/4"	4"	3-3/4"	150	7	.002	1/4"
1"	5"	4-1/4"	150	9	.002	1/4"
1-1/2"	7"	5"	150	17	.007	1/4"
2"	9"	6-1/2"	150	32	.016	1/4"
2-1/2"	10"	7"	150	40	.028	1/4"
3"	12"	8"	150	55	.049	1/4"
4"	12-1/2"	10-5/8"	150	85	.091	1/4"
5"	16-1/2"	11-1/2"	150	119	.187	1/4"
6"	20"	13"	150	166	.327	1/4"
8"	22"	16-1/4"	125	235	.640	1/4"
10"	24"	21"	100	425	1.09	1/4"
12"	26"	24"	100	640	1.70	1/4"
14"	30"	22"	75	780	2.39	1/4"
16"	34"	29-1/2"	75	910	3.59	1/4"
18"	39"	30-1/2"	50	1,275	5.27	3/4"
*20" x 24"	43"	31"	50	1,704	7.25	1"
*24" x 28"	51"	38-1/2"	50	2,100	12.5	1"

## Type A – Double Wall

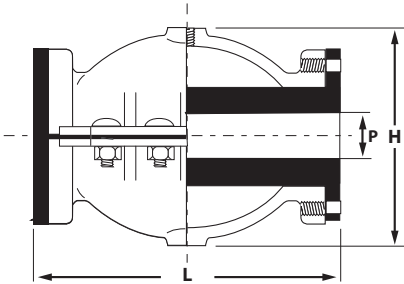

VALVE SIZE	PORT SIZE P	LENGTH L	HEIGHT H	WORKING PRESSURE psi	WEIGHT CAST IRON lbs	AIR INLET NPT
1"	1/2"	5"	4-1/4"	150	11	1/4"
2"	1"	9"	6-1/2"	150	33	1/4"
2-1/2"	1-1/2"	10"	7"	150	42	1/4"
3"	2"	12"	8"	150	57	1/4"
4"	2-1/2"	12-1/2"	10-5/8"	150	88	1/4"
4"	3"	12-1/2"	10-5/8"	150	88	1/4"
5"	4"	16-1/2"	11-1/2"	150	123	1/4"
6"	5"	20"	13"	150	171	1/4"
8"	6"	22"	16-1/4"	125	239	1/4"
10"	8"	24"	21"	100	432	1/4"
12"	10"	26"	24"	100	648	1/4"
14"	12"	30"	22"	75	826	1/4"
16"	14"	34"	29-1/2"	75	970	1/4"
18"	16"	39"	30-1/2"	50	1,343	3/4"
*20" x 24"	18"	43"	31"	50	1,800	1"
*24" x 28"	20"	51"	38-1/2"	50	2,365	1"

7

## Type A – Cone

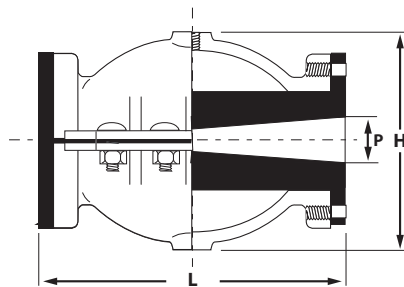

VALVE SIZE	AVAILABLE PORT SIZES P**	LENGTH L	HEIGHT H	WORKING PRESSURE psi	WEIGHT CAST IRON lbs	AIR INLET NPT
1"	1/4", 1/2", 3/4"	5"	4-1/4"	150	9	1/4"
1-1/2"	3/4", 1", 1-1/4"	7"	5"	150	17	1/4"
2"	3/4", 1", 1-1/2"	9"	6-1/2"	150	32	1/4"
2-1/2"	1", 1-1/2", 2"	10"	7"	150	40	1/4"
3"	1-1/2", 2", 2-1/2"	12"	8"	150	55	1/4"
4"	2", 2-1/2", 3"	12-1/2"	10-5/8"	150	85	1/4"
5"	2-1/2", 3", 4"	16-1/2"	11-1/2"	150	119	1/4"
6"	3", 4", 5"	20"	13"	150	166	1/4"
8"	4", 5", 6"	22"	16-1/4"	125	235	1/4"
10"	5", 6", 8"	24"	21"	100	425	1/4"
12"	6", 8", 10"	26"	24"	100	640	1/4"
14"	8", 10", 12"	30"	22"	75	810	1/4"
16"	10", 12", 14"	34"	29 1/2"	75	940	1/4"
18"	12", 14", 16"	39"	30 1/2"	50	1,321	3/4"
*20" x 24"	14", 16", 18"	43"	31"	50	1,770	1"
*24" x 28"	16", 18", 20"	51"	38 1/2"	50	2,277	1"

\* Valve uses extended flange.

\*\* Other port sizes available - consult factory.

# Miniflex

- ▶ Simple, automatic valve design
- ▶ Body acts as built-in actuator
- ▶ No need for actuators or electric motors
- ▶ Threaded-end connections for easy installation and removal
- ▶ Cost effective, maintenance free
- ▶ Full-port design



## Materials of Construction

8

- ▶ Steel, stainless steel or PVC body
- ▶ Steel, stainless steel or PVC end connections
- ▶ Optional food-grade Ladish Tri-Clamp
- ▶ Molded sleeves without reinforcement ply
- ▶ Sleeves available in Pure Gum Rubber, Neoprene, Hypalon®, Chlorobutyl, Buna-N, EPDM, Viton® and food-grade rubber

Manufactured on the same design principles as Red Valve's Type A Valve, Series 2600 Miniflex Valves are the simplest and least expensive actuated pinch valves available today. The Series 2600 is designed with threaded-end connections, enabling use on small lines (1/8" - 2").

Miniflex Valves are pneumatically actuated, using the valve body as a built-in actuator. Air pressure opens and closes the rubber sleeve, eliminating costly actuators or electric motors and the accompanying maintenance costs. Only 25 psi over line pressure is required for closure. Threaded-end connections enable easy installation and removal.

The Miniflex Valve has only four parts and requires little or no maintenance. The valve cycles rapidly, making it ideal for sampling, filling and controlling. The elastomer sleeve is molded and does not have fabric reinforcement, making it easier to open and close. The 2600 is also an excellent choice for chemical feeding, dry powder, bagging and plastic molding applications with controlling acids, slurries, reagents or catalysts.

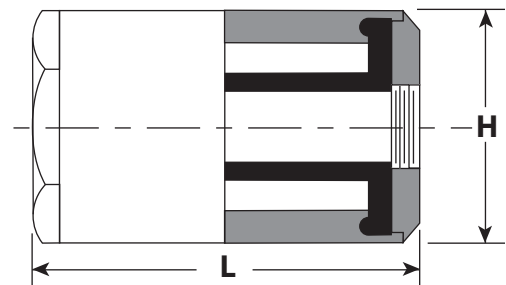

## Series 2600

VALVE SIZE	LENGTH L	HEIGHT H	WORKING PRESSURE psi	WEIGHT lbs*
1/8"	3"	1-1/2"	75	1
1/4"	3"	1-1/2"	75	1
3/8"	3-1/2"	2-1/8"	75	1-1/2
1/2"	3-1/2"	2-1/8"	75	2
3/4"	4"	2-1/4"	75	2-1/2
1"	4-1/2"	2-3/4"	75	3
1-1/4"	6-1/2"	4"	50	9
1-1/2"	6-1/2"	4"	50	9
2"	7"	4"	50	10

\* Weights indicate steel bodies and end caps.

# Type A Megaflex

- ▶ **Cost-effective, large-diameter valve**
- ▶ **Body acts as built-in actuator**
- ▶ **Simple two-piece design: body and sleeve**
- ▶ **No packing or seats to maintain, ever**
- ▶ **Seals on solids**
- ▶ **Full-ported design eliminates headloss, reduces pumping costs**

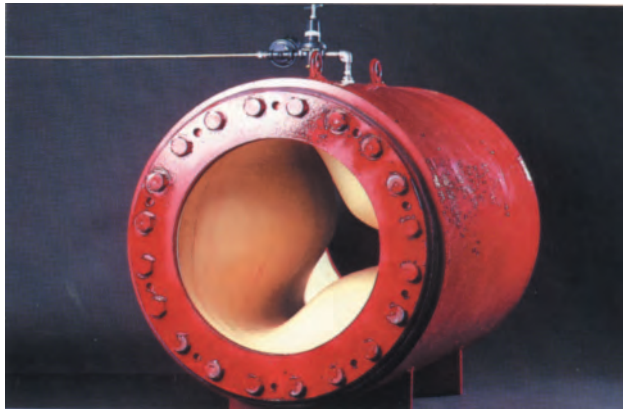

## Materials of Construction

- ▶ **Carbon steel body**
- ▶ **Sleeves available in Pure Gum Rubber, Neoprene, Hypalon®, Chlorobutyl, Buna-N, EPDM and Viton®**
- ▶ **ANSI Class 125/150**

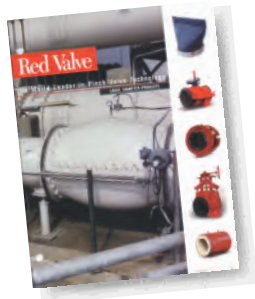

Large-diameter product brochure available.

Because it eliminates costly actuators, the Type A Megaflex is the most economical large-diameter automatic valve available.

First introduced by Red Valve, the Type A Megaflex Valve is available in sizes 30" - 84" and is extremely simple in design and principle. As with every Red Valve Pinch Valve, the elastomer sleeve is the only wetted part, drastically reducing maintenance costs. The Megaflex Valve's full-ported actuation is accomplished by air or hydraulic pressure. The steel body acts as a built-in actuator, eliminating costly pneumatic, electric or hydraulic components. Pressure within the space between the body and the sleeve can open, throttle or close the valve. Unlike traditional gate and butterfly valve designs, there are no discs or gates to obstruct flow or create turbulence.

Like all Red Valve Pinch Valves, Megaflex Valves are full-ported. *Thousands of dollars of savings are realized* because Megaflex Valves have little headloss, substantially reducing pumping costs.

Type A Megaflex Valves are often specified as effluent discharge valves controlling raw sewage, storm overflow, flow equalization, tailings in mining operations and bulk material handling.

Red Valve also manufactures a line of large-diameter manually or electrically operated Pinch Valves in sizes 30" - 96".

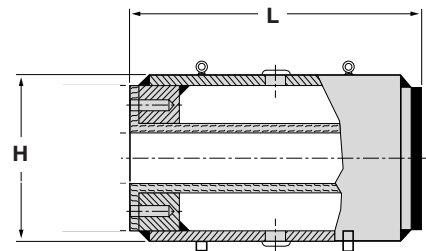

**Megaflex**

VALVE SIZE	LENGTH L	HEIGHT H	WORKING PRESSURE psi*	WEIGHT lbs
30"	60"	40"	50	4,100
36"	72"	48"	50	5,000
48"	96"	60"	50	6,200
60"	120"	74"	50	7,900
72"	144"	87"	25	9,900
84"	168"	100"	25	10,500

\* Higher working pressures available.

# Series 5200 Control Valve

- ▶ High cycle life, repeatable control
- ▶ Sleeve is the only component in contact with the media, eliminating the need for expensive alloy bodies
- ▶ Versatile choice of sleeve trims to meet exact flow requirements
- ▶ External stroke adjustment
- ▶ Bi-directional, drop-tight shutoff

The Red Valve Series 5200 Control Valve design offers maximum durability with precise control and virtually eliminates maintenance. A heavy-duty pinch mechanism positions the sleeve for accurate control over a wide flow range. The valve has no packing to maintain or seats to wear, and the elastomer sleeve eliminates the need for expensive alloy bodies.

In sizes over 4", a bottom pinch bar is used to reduce the stroke length of the valve by pre-pinching the sleeve into a D-shaped port. The D-Port provides a more immediate response to control signal with no loss of flow capacity.

Cone Sleeves can be specified to further enhance control performance and match the exact Cv level desired. True feedback positioning is accomplished through the direct linkage of the pneumatic positioner to the valve stem shaft. There is no splitting of the positioner output. The benefits of true feedback positioning on Red Valve's Series 5200 valves are accurate small-change response signals to the positioner, causing similar changes in true valve position, greatly enhancing control accuracy.

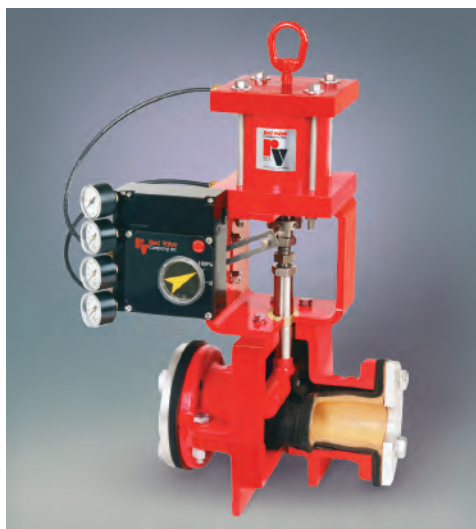

## 10 Materials of Construction

- ▶ Ductile iron body
- ▶ Actuators: ATO/ATC, ATO/FC, ATC/FO
- ▶ Sleeves available in Pure Gum Rubber, Neoprene, Hypalon®, Chlorobutyl, Buna-N, EPDM and Viton®
- ▶ Drilled and tapped to mate with ANSI B16.5 Class 150 flanges



Complete Control Valve brochure and binder available.

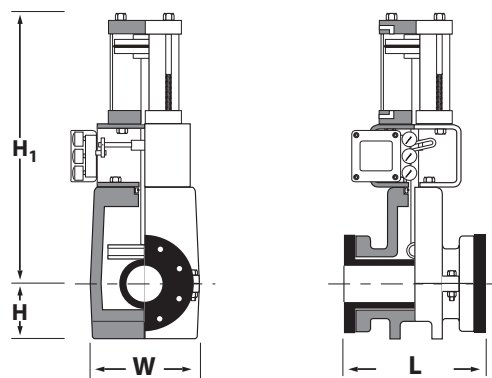

## Series 5200

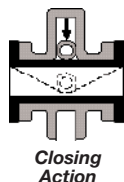

VALVE SIZE	LENGTH L	WIDTH W	HEIGHT		WORKING PRESSURE psi**	WEIGHT ATO/ATC lbs*
			H	ATO/ATC H <sub>1</sub> *		
1"	7-1/4"	6"	2-7/16"	19"	150	50
1-1/2"	8-3/4"	8"	2-3/4"	19"	150	95
2"	10"	8"	3-1/2"	22"	150	125
2-1/2"	10-7/8"	9"	4"	24"	150	150
3"	11-3/4"	11-1/2"	4-1/4"	26"	150	185
4"	13-7/8"	13-1/2"	6-5/8"	29"	150	225

\* Consult factory for specific heights and weights of fail-close or fail-open valves.

\*\* Higher working pressures available.

For larger valve sizes up to 72", consult factory.

## Series 5200 – D Port

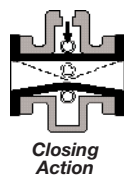

6"	17-3/4"	16-7/8"	7-5/8"	36"	150	305
8"	21-3/8"	19-7/8"	9-1/8"	43"	125	395
10"	26-1/2"	23-1/2"	11"	43"	100	520
12"	29"	27-1/2"	11-13/16"	46"	100	709
14"	28"	31"	14"	51"	75	1,200
16"	32"	34"	15"	56"	50	1,600
18"	36"	44"	16-1/2"	59"	50	2,000
20"	40"	40"	17"	62"	50	2,450

# Series 5200E Control Valve

- ▶ Electric actuation provides precise, accurate control
- ▶ Sleeve is the only wetted part, so breakaway torques remain constant
- ▶ Bi-directional, drop-tight shutoff
- ▶ Enclosed rising stem design



## Materials of Construction

- ▶ Ductile iron body
- ▶ Sleeves available in Pure Gum Rubber, Neoprene, Hypalon®, Chlorobutyl, Buna-N, EPDM and Viton®
- ▶ Drilled and tapped to mate with ANSI B16.5 Class 150 flanges
- ▶ AUMA, Limitorque, Rotork and other electric actuators available

The Series 5200E Electrically Actuated Control Valve is a reliable, maintenance-free, cost-effective valve, designed for tough slurry and abrasive applications. There are no seats to grind, no stuffing boxes to repack and no packing glands to adjust, ever. The rugged, self-cleaning elastomer sleeve isolates all mechanical parts of the valve, so the breakaway torque remains constant.

Red Valve Series 5200E Electrically Actuated Control Valves are actuated by AUMA, Limitorque or Rotork electric operators as a standard and include heaters, thermostats, position indicators and indication lights. Other electric motor operators are available upon request. Declutch and override components are furnished as standard. Controls can be furnished as an integral part of the electric operator or as a separate unit for a remote station. Optional features include: NEMA 7 explosion-proof construction, proportioning control from a 4-20 mA instrument signal and 4-20 mA output transmitter.

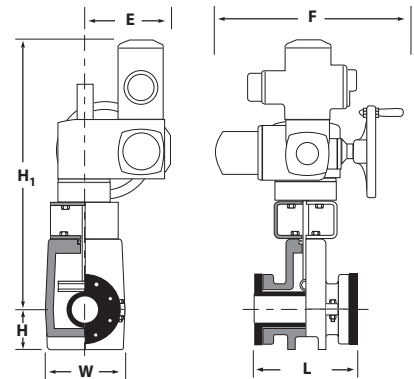

11

## Series 5200E - Modulating Actuator

VALVE SIZE*	LENGTH L	WIDTH W	HEIGHT		ACTUATOR WIDTH E**	ACTUATOR LENGTH F**	WORKING PRESSURE psi	WEIGHT lbs
			H	H <sub>1</sub> **				
1"	7-1/4"	6"	2-7/16"	28-1/8"	9-1/3"	19-1/2"	150	87
1-1/2"	8-3/4"	8"	2-3/4"	28-1/4"	9-1/3"	19-1/2"	150	131
2"	10"	8"	3-1/2"	28-3/8"	9-1/3"	20-3/8"	150	164
2-1/2"	10-7/8"	9"	4"	29-5/8"	9-3/4"	21-1/8"	150	207
3"	11-3/4"	11-1/2"	4-1/4"	30-13/16"	9-3/4"	21-1/8"	150	240
4"	13-7/8"	13-1/2"	6-5/8"	34-1/8"	11-1/4"	27-3/4"	150	356
6"	17-3/4"	16-7/8"	7-5/8"	35-1/8"	11-1/4"	28"	150	443
8"	21-3/8"	19-7/8"	9-1/8"	37-7/8"	12-1/8"	33-7/8"	125	675
10"	26-1/2"	23-1/2"	11"	39-13/16"	12-1/8"	33-7/8"	100	810
12"	29"	27-1/2"	11-13/16"	40-5/8"	12-1/8"	33-7/8"	100	999
14"	28"	31"	14"	42-13/16"	12-1/8"	33-7/8"	75	1,490
16"	32"	34"	15"	43-13/16"	12-1/8"	33-7/8"	50	1,890
18"	36"	44"	16-1/2"	46-1/4"	14-7/16"	36-7/16"	50	2,630
20"	40"	40"	17"	46-13/16"	14-7/16"	36-7/16"	50	3,180
24"	48"	57"	20-1/2"	74-1/4"	15-13/16"	41"	50	3,845
30"	60"	78"	20-1/2"	57"	19-1/8"	51"	50	6,930
36"	72"	94"	32"	69"	19-1/8"	51"	40	12,000
42"	84"	110"	38"	80"	20-5/8"	55-5/8"	35	19,000
48"	96"	125"	43"	92"	20-5/8"	55-5/8"	30	28,500
54"	108"	141"	49"	104"	20-5/8"	55-5/8"	25	40,000

\* Sizes over 4" are D-Port design.

\*\* Dimensions are based on AUMA and are for reference only. Contact factory for exact dimensions.

For larger valve sizes up to 72", consult factory.

# Series 5400 Control Valve

- ▶ Heavy-duty valve design actuator closes on centerline
- ▶ No packing to maintain, ever
- ▶ Accurate, repeatable control
- ▶ Ideal for corrosive and abrasive slurries
- ▶ True feedback positioning



Red Valve's Series 5400 Control Pinch Valve features centerline closure, true feedback positioning, a compact size and accurate, repeatable variable venturi flow control.

Centerline closure is extremely important for larger size pinch sleeves on abrasive and high velocity applications. Centerline closure outlasts all other types of gate, plug or ball valves on control of abrasive and corrosive slurries. The resilient elastomer sleeve out-lasts even stellite-coated control valves.

Cone Sleeves can be specified to further enhance control performance and match the exact Cv level desired. True feedback positioning is accomplished through the direct linkage of the pneumatic positioner to the valve stem shaft. The benefits of true feedback positioning on Red Valve Series 5400s include accurate small responsive signal changes to the positioner, causing similar changes in true valve position, greatly enhancing control accuracy and repeatability.

## 12 Materials of Construction

- ▶ Ductile iron body
- ▶ ATO/ATC, ATO/FC, ATO/FO, hydraulic or electric actuators
- ▶ Sleeves available in Pure Gum Rubber, Neoprene, Hypalon®, Chlorobutyl, Buna-N, EPDM and Viton®
- ▶ Drilled and tapped to mate with ANSI B16.5 Class 150 flanges

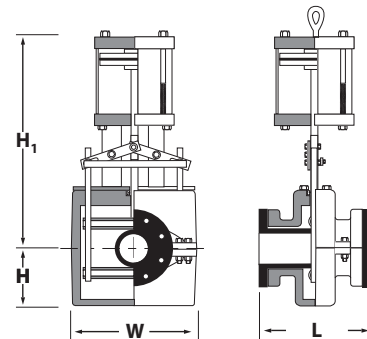

## Series 5400

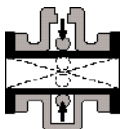

Closing Action

VALVE SIZE	LENGTH L	WIDTH W	HEIGHT		WORKING PRESSURE psi**	WEIGHT ATO/ATC lbs*
			H	ATO/ATC H <sub>1</sub> *		
4"	9"	10-1/2"	5-3/4"	26-1/2"	150	210
5"	10"	15-3/8"	8-1/2"	32"	150	250
6"	10-1/2"	18-1/4"	7-7/8"	32-1/8"	150	288
8"	16"	23-1/4"	9-1/8"	32-1/2"	150	385
10"	20"	29-3/4"	10-1/2"	43"	150	520
12"	24"	35"	11-1/2"	46"	150	709
14"	28"	37-1/2"	14-1/2"	51-3/4"	150	1,200
16"	32"	41-1/2"	15-1/2"	56-1/2"	150	1,600
18"	36"	51"	17"	59-1/2"	150	2,000
20"	40"	47-3/4"	17-3/4"	62-3/4"	150	2,450
24"	48"	57"	25-1/2"	***69"	150	4,200
30"	60"	78"	20-1/2"	***74"	50	8,300
36"	72"	77"	32"	***96"	45	14,300
42"	84"	92"	36"	***124"	40	28,500
48"	96"	106"	41"	***136"	35	42,500
54"	108"	120"	48"	***148"	30	60,000

\*Consult factory for specific heights and weights of fail-close or fail-open valves.

\*\*Higher working pressures available.

\*\*\*Hydraulic or electric only.

For larger sizes up to 72", consult factory.

# Series 9000 Pinch Valve

- ▶ Working pressures up to 720 psi
- ▶ High-pressure pinch valve design for on/off applications
- ▶ Heavy-duty polyester of Kevlar®-reinforced high-pressure sleeve is the only wetted part
- ▶ Extended service life
- ▶ Sealed-body design



The Series 9000 High-Pressure Pinch Valve is Red Valve's ANSI Class 300 pinch valve product. With Red Valve's Double Wall Sleeve, the valve features increased abrasion resistance and can accommodate pressures up to 720 psi. The Series 9000 is also available with Red Valve's patented Cone Sleeve for control applications and the Standard Sleeve for lower pressure requirements.

A heavy-duty solid stroke adjustment unit located on the base of the Series 9000 allows the user to fine-tune control or adjust stroke for sleeve wear due to abrasion, reducing system downtime.

The Series 9000 is available with various actuators: bevel gear actuators for manual operation, hydraulic or electric actuators for automatic operation and pneumatic actuators for small sizes or low-pressure applications.

For applications with low pressure requirements, the Series 9000 is also available in ANSI Class 150 drilling configurations.

## Materials of Construction

- ▶ Ductile iron, 316 stainless steel bodies
- ▶ Sleeves available in Pure Gum Rubber, Neoprene, Hypalon®, Chlorobutyl, Buna-N, EPDM and Viton®
- ▶ Bevel Gear 4:1, 8:1, 16:1 actuator, electric actuator or hydraulic actuator
- ▶ Drilled and tapped to mate with ANSI B16.5 Class 300 flanges, ANSI B16.1 Class 250 flanges, optional Class 150 flanges

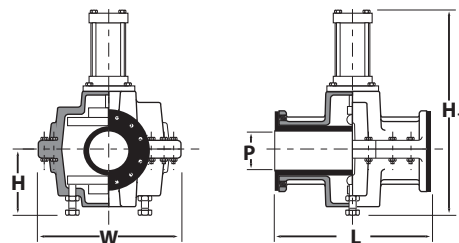

13

## Series 9000

VALVE SIZE	FULL - PORT SLEEVE		DOUBLE - WALL SLEEVE		LENGTH L	WIDTH W	HEIGHT		WEIGHT lbs
	PORT SIZE P	MAX WORKING PRESSURE AT 100°F psi**	PORT SIZE P***	MAX WORKING PRESSURE AT 100°F psi**			H	H <sub>1</sub>	
1"	1"	720	1/2"	720	7-3/4"	12"	6"	16"	73
2"	2"	335	1-1/2"	720	9-1/2"	16"	8"	22"	229
3"	3"	240	2"	720	10-3/4"	17"	9"	26"	335
4"	4"	185	3"	720	14"	20"	11"	28"	438
6"	6"	245	4"	720	20"	23"	13"	33"	600
8"	8"	250	6"	720	26"	25"	15"	39"	802
10"	10"	200	8"	720	32-1/2"	33"	20"	51"	1,083
12"	12"	175	10"	720	38-1/2"	40"	25"	62"	1,477
14"	14"	320	12"	720	45"	45"	28"	68"	2,350
16"	16"	360	14"	720	51"	51"	31"	74"	3,500
18"	18"	265	16"	720	57-1/2"	56"	34"	80"	5,000
20"	20"	240	18"	720	64"	62"	37"	87"	6,850
24"	24"	250	20"	720	77"	71"	40"	100"	11,800
26"	26"	150	24"	720	83"	77"	43"	108"	15,000

\*With hydraulic cylinder.

\*\*Higher working pressures available.

\*\*\*Other port sizes available - consult factory.

# Manual Pinch Valves

- ▶ Same Face-to-Face As Gate, Plug and Ball Valves To 12"
- ▶ 100% Full Port
- ▶ Bi-Directional, Drop-Tight Shutoff
- ▶ No Packing To Maintain, Ever
- ▶ Sleeve Is Only Wetted Part: No Need For Alloy Bodies
- ▶ Self-Cleaning
- ▶ Excellent Throttling Characteristics

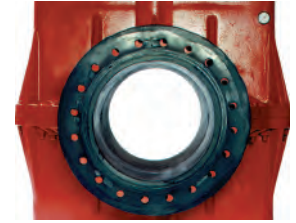
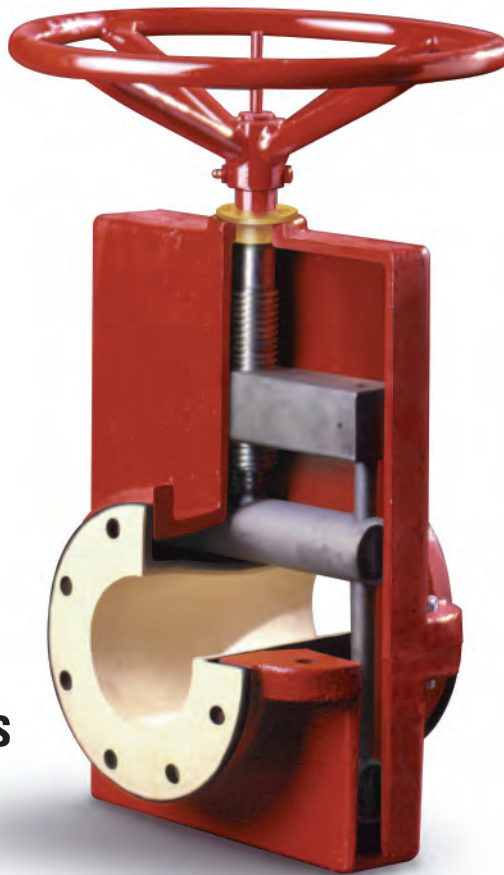

*The Series 75's flexible sleeve isolates the valve's working parts.*



*Two pinch bars close on centerline, eliminating turbulence and wear, and provide a smooth closing venturi that self-cleans with each operation.*



*Fully closed, the Series 75 ensures drop-tight, bi-directional shutoff and an intrinsically safe design with no packing to maintain.*

14



## ▶ Power Plants

FGD systems, scrubber systems, coal handling, fly ash, bottom ash



## ▶ Wastewater Treatment Plants

Sludge handling, grit removal, raw sewage, lime, carbon slurry, digester gas



## ▶ Mining

Tailings, flotation control, thickener underflow lines, numerous other slurry applications



## ▶ Chemical Processes

Corrosive and abrasive material, powders, pellets, waste treatment



# Series 75/Series 70 Pinch Valves

- ▶ Same face-to-face as gate, plug and ball valves
- ▶ 100% full-port design
- ▶ Bi-directional, bubble-tight shutoff
- ▶ No packing to maintain, ever
- ▶ Sleeve is the only wetted part, reducing maintenance and alloy body costs
- ▶ Non-contaminating, intrinsically safe design eliminates fugitive emission problems

The Series 70 and 75 Manually Operated Pinch Valves are reliable, maintenance-free, cost-effective valves designed for slurry, abrasive- and corrosive-chemical applications. There are no seats to grind, no stuffing boxes to repack and no packing glands to adjust, ever. The pinching action is on centerline, so the valve closes on a smooth venturi and is self-cleaning.

The heart of this unique valve is the durable, flexible rubber sleeve which is reinforced with high-strength fabric. The sleeve, which is the only part of the valve exposed to the line process, eliminates maintenance and the need for expensive materials. Additionally, valve operation will not freeze, and operating torques remain constant. The design principle is very simple – two mechanical pinch bars open and close the elastomer sleeve.

Because of its excellent control characteristics, the Manual Pinch Valve can be used as a variable orifice. Few manual valves have this throttling advantage. Plus, zero leakage is maintained bi-directionally. A number of options are available, such as the Series 75B design for buried service conditions. AWWA nuts, chainwheels, stem extensions and bevel gear actuators are also available.



Series 75



Series 70

## Materials of Construction

- ▶ Cast iron or aluminum body (75)  
Fabricated steel, open-frame design (70)
- ▶ Sleeves available in Pure Gum Rubber, Neoprene, Hypalon®, Chlorobutyl, Buna-N, EPDM and Viton®
- ▶ ANSI Class 125/150



Manual Pinch Valve brochure available.

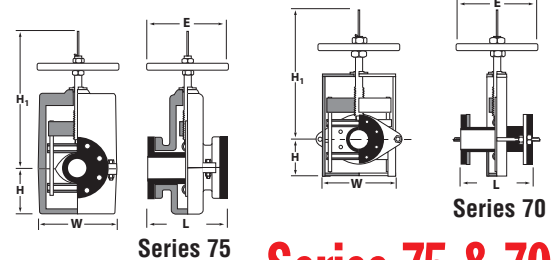

Series 75

Series 70

## Series 75 & 70

VALVE SIZE	LENGTH L	WIDTH W	HEIGHT		HANDWHEEL DIAMETER E	WORKING PRESSURE psi	SERIES 75 WEIGHT lbs	SERIES 70 WEIGHT lbs
			H	H <sub>1</sub>				
*1 x 1/2"	5-1/2"	5-7/8"	10-1/2"	2-7/8"	6"	150	20	15
*1 x 3/4"	5-1/2"	5-7/8"	10-1/2"	2-7/8"	6"	150	20	15
1"	5-1/2"	5-7/8"	10-1/2"	2-7/8"	6"	150	20	15
1-1/2"	6-1/2"	9"	12"	3-5/8"	6"	150	34	20
2"	7"	10-1/2"	15-3/4"	5-3/8"	8"	150	50	25
2-1/2"	7-1/2"	9-1/2"	16-1/4"	4-3/4"	12"	150	62	36
3"	8"	9-1/2"	16-1/4"	5"	12"	150	80	40
4"	9"	10-3/4"	17-1/2"	5-1/2"	12"	150	85	50
5"	10"	15-3/8"	24-1/2"	7-3/4"	**18"	150	170	100
6"	10-1/2"	18-1/4"	24-1/4"	8-3/8"	**18"	150	186	100
8"	16"	23-1/4"	34"	9-3/4"	**18"	125	400	180
10"	20"	31-1/4"	37"	10"	**18"	100	500	200
12"	24"	35"	38"	12"	**18"	100	650	260
14"	28"	37"	36"	14-3/8"	**18"	75	1,030	473
16"	32"	36-3/8"	40"	15-1/2"	**18"	50	1,250	560
18"	36"	44"	43"	20-1/2"	**18"	50	1,400	690
20"	40"	49-1/4"	45"	21"	**18"	50	1,610	770
24"	48"	51"	51-1/2"	25"	**18"	50	2,028	1,150

\*1" flange with smaller port opening.

\*\*Bevel gear operators recommended. Diameter without bevel gear is 24".

For larger sizes up to 72", consult factory.

# Tideflex® TF-2

Invented, developed and tested by Red Valve Company

- ▶ 100% elastomer construction
- ▶ Will not rust or corrode
- ▶ Will not warp or freeze open or shut
- ▶ Custom-built to customer specifications
- ▶ Low cracking pressure, low headloss
- ▶ Eliminates backflow



## Materials of Construction

- ▶ Neoprene, Hypalon®, Buna-N, EPDM, Viton® and NSF-61-approved SBR

## 16 Mounting Bands/Backup Rings

- ▶ Carbon steel, galvanized steel or stainless steel

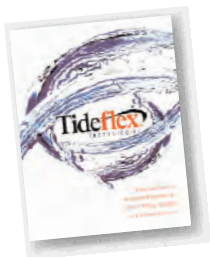

Tideflex® Check Valve brochure and binder available.



Request a FREE copy of Red Valve's "Simply Revolutionary" Tideflex® video.

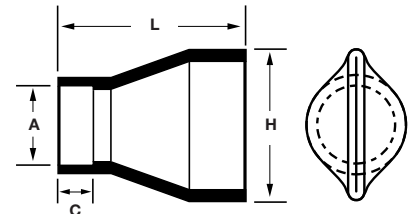

Red Valve's Tideflex® TF-2 Check Valve has a revolutionary design for backflow prevention. It offers low cracking pressure to eliminate standing water and very low headloss that is not affected by rust, corrosion or lack of lubrication. Tideflex® Check Valves are cost-effective because they require no maintenance or repairs and have a long operational life span. Tideflex® operate using line pressure and backpressure to open and close, so no outside energy source is required. Sliding, rotating, swinging and plunging parts are completely eliminated.

Tideflex® Valves are excellent replacements for ineffective metal flapgate valves. Millions of dollars each year are lost in the retreatment of unnecessary backflow because of faulty check valves that have corroded open or have been wedged open by debris. Tideflex® Check Valves close drop-tight and seal around debris with less than one psi of backpressure. Tideflex® Valves will not warp or freeze and are virtually maintenance free. They will handle large obstructions without jamming, and there is no gate to hang open.

The inside diameter of the TF-2's cuff is constructed to exactly match the outside diameter of the pipe. The valve is slid onto the pipe and held in place with steel or stainless steel band clamps, eliminating flanging costs. Tideflex® TF-2 Valves 18" and larger are constructed with a curved bill as standard.

PIPE O.D. A	LENGTH L	BILL HEIGHT H	CUFF LENGTH C
3/4"	3"	1-1/2"	1"
1"	3"	1-1/2"	1"
1-1/2"	6"	3"	1"
2"	6"	4"	1"
2-1/2"	8"	5"	1"
3"	9"	5-1/2"	1-1/2"
4"	12"	7"	1-1/2"
5"	15-1/2"	9"	2"
6"	16"	10-1/2"	2"
8"	16-1/2"	13"	2"
10"	21-1/2"	17"	3"
12"	26-1/2"	20-1/2"	4-1/2"
14"	26"	22"	4"
16"	26"	27"	5"
18"	30"	29"	6"
20"	33"	33"	8"
22"	36"	33"	8"
24"	39"	37"	8"
26"	39"	37"	8"

Numbers indicate maximum dimensions.

PIPE O.D. A	LENGTH L	BILL HEIGHT H	CUFF LENGTH C
28"	39"	37"	8"
30"	42"	50"	9"
32"	48"	53"	10"
36"	49"	61"	10"
38"	49"	61"	10"
40"	49"	61"	10"
42"	54"	71"	10"
44"	54"	71"	10"
48"	59"	78"	10"
50"	59"	78"	10"
54"	69"	97"	10"
58"	69"	97"	10"
60"	74"	97"	14"
68"	74"	97"	14"
72"	95"	115"	16"
84"	92"	111"	16"
90"	101"	119"	16"
92"	101"	119"	16"
96"	101"	119"	16"

# Tideflex® TF-1

Invented, developed and tested by Red Valve Company

- ▶ Ideal for manhole installations
- ▶ Minimal bottom clearance required
- ▶ Lightweight, all elastomer design
- ▶ Seals around entrapped solids
- ▶ Available in slip-on or flanged design

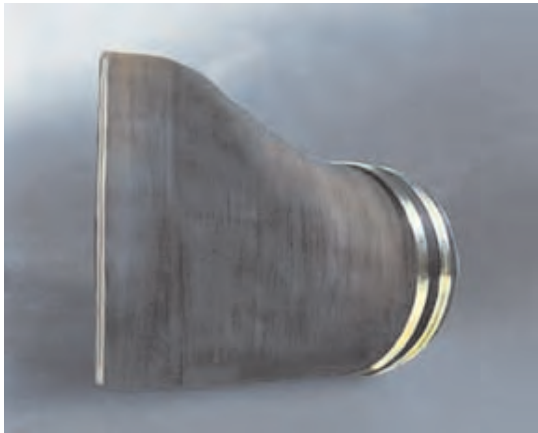

## Materials of Construction

- ▶ Neoprene, Hypalon®, Buna-N, EPDM, Viton® and NSF-61-approved SBR

## Mounting Bands/Backup Rings

- ▶ Carbon steel, galvanized steel or stainless steel

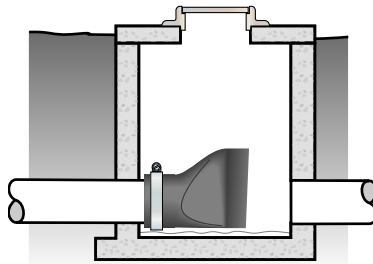

The TF-1 is designed for installation in existing structures such as interceptors, manholes and vaults. These structures are designed to maintain the maximum amount of head pressure from gravity; thus, the invert pipe is as close to the floor or base of the structure as possible. The flat-bottom and offset-bill design of the TF-1 allows it to be installed without any modifications to the structure.

The TF-1 offers low cracking pressure to eliminate standing water and very low headloss that is not affected by rust, corrosion or lack of lubrication. Tideflex® Check Valves are cost-effective because they require no maintenance or repairs and have a long operational life span. Tideflex® operate using line pressure and backpressure to open and close, so no outside energy source is required. Sliding, rotating, swinging and plunging parts are completely eliminated.

The TF-1 is ideal for sewer systems because it will seal around small debris with less than one psi of backpressure. Tideflex® Valves will not warp or freeze and are virtually maintenance free. The TF-1 design is available with a slip-on or flanged-pipe connection. Tideflex® TF-1 Valves 18" and larger are constructed with a curved bill as standard.

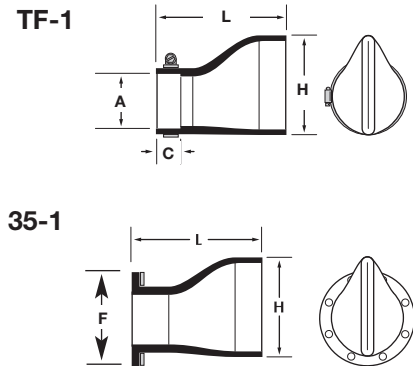

TF-1		35-1		LENGTH L	HEIGHT H
PIPE O.D. A	CUFF LENGTH C	FLANGE SIZE ANSI	FLANGE O.D. F		
4"	1-1/2"	4"	9"	10"	8"
6"	2"	6"	11"	14"	11-1/2"
8"	2"	8"	13-1/2"	17-1/2"	15-1/2"
10"	3"	10"	16"	21-1/2"	19"
12"	4"	12"	19"	26"	22-1/2"
16"	5"	16"	23-1/2"	32"	30"
20"	8"	20"	27-1/2"	42"	37"
24"	8"	24"	32"	46"	43"
30"	9"	30"	38-3/4"	56"	55"
36"	10"	36"	46"	65"	69"
42"	10"	42"	53"	60"	71"
48"	10"	48"	59-1/2"	65"	78"
60"	13"	60"	73"	73"	91"
72"	16"	72"	86-1/2"	84"	110"

Numbers indicate maximum dimensions.

## Pumping Stations

Large stormwater pumping stations use Tideflex® Check Valves to ensure that tailwater does not backflow into stormwater catchments.

The rubber construction of the Tideflex® Valve is resistant to saltwater, and low headloss characteristics are ideal for low-lying areas.



## Sewer Systems

Tideflex® Valves prevent floodwaters from surcharging sewer lines and washing raw sewage into streets and basements.



## Effluent Discharge

Tideflex® Valves protect discharge lines from rising waters that can flood and surcharge a treatment plant. Ecosystems are also protected by the Tideflex® Check Valve's ability to diffuse effluent and prevent backflow.



# Tide Techn Engine Reli Perfor

## Airport/Highway Runoff

Tideflex® Valves are used extensively for large surface water areas that require backflow prevention, such as airport runways, highways and parking lots. Tideflex® provides an ideal solution where regulations require treatment of toxic hydrocarbons from runoff.



## CSO/SSO Systems

Combined sewer and sanitary sewer overflow systems use Tideflex® Valves to prevent receiving water from backflowing to the sewage treatment plant. The new flat-bottom TF-1 is designed for CSO/SSO manhole installations.





## Stormwater Discharge

*Tideflex® Check Valves are the first choice of coastal and inland municipalities for stormwater systems. Tideflex® Valves discharge with 1" of differential pressure, which maximizes pipeline storage capacity.*



**flex®**  
**ology:**  
ered for  
able  
mance.

## Site Drainage

*Residential areas, office parks and commercial shopping centers use Tideflex® Valves to allow the free flow of stormwater and to prevent backflow and flooding from canals, streams and rivers.*



## Flood Control Systems

*Tideflex® Valves are used extensively for flood control. They can sit inactive for years and still be ready to provide backflow protection in the event of a flash flood. Typical applications include retention basins, levees, locks and dams, fish bypass systems, city stormwater collection systems, highways, parking lots, airport runways and large industrial and office complexes.*



# Series 39 InLine Check Valve

- ▶ Elastomer check valve resists abrasion and provides absolute backflow prevention
- ▶ Seals on entrapped solids
- ▶ No hinges or seats to bind or freeze - a maintenance-free design
- ▶ Can be mounted in any position
- ▶ Silent, non-slamming; eliminates chatter

The Red Valve Series 39 InLine Check Valve is designed to handle abrasive slurries, sewage, sludge and other difficult materials. The heart of the Series 39 Check Valve is a fabric-reinforced elastomer check sleeve that provides thru-flow at minimum pressure drop across the valve at all times. Forward pressure opens the valve automatically, and reverse pressure seals the valve.

Wear and deterioration caused by continuous operation of abrasive slurries is minimized because of the inner rubber check valve. There are no mechanical parts such as hinges, discs or metal seats that can freeze, corrode or bind. The unique elastomer check sleeve will seal on solids. The valve's operation is silent and non-slamming.

Face-to-face dimensions meet ANSI B16.10 specs. The valve has thru-drilled flange holes. When ordering, specify maximum line pressure and backpressure.

Also available, Saddle Support Technology increases the backpressure rating of Tideflex® InLine Check Valves. Constructed of steel or stainless steel, the saddle support nests inside the Tideflex® to support the saddle area of the valve.



## Materials of Construction

- 20 ▶ Cast iron ASTM A126 sizes up to 24"  
 ▶ Fabricated steel body in sizes 30" - 48"  
 ▶ Check sleeves available in Pure Gum Rubber, Neoprene, Hypalon®, Chlorobutyl, Buna-N, EPDM and Viton®  
 ▶ ANSI Class 125/150  
 ▶ Epoxy coating or rubber-lined body available  
 ▶ Steel or stainless steel saddle support



*InLine Check Valve brochure available.*

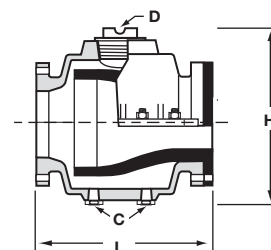

## Series 39

VALVE SIZE	LENGTH L	HEIGHT H	CLEAN OUT PLUG SIZE D	FLUSH CONNECTIONS C		MAX. BACKPRESSURE psi	
				QTY	SIZE	STANDARD TIDEFLEX®	SADDLE SUPPORT
*1"	4-1/2"	4-1/4"	NONE	2	1/2"	150	225
*1-1/2"	6-1/2"	5"	NONE	2	1/2"	150	225
*2"	8-1/2"	6-1/2"	NONE	2	1/2"	150	225
*2-1/2"	9-1/2"	7"	NONE	2	1/2"	150	225
*3"	11-1/4"	8"	NONE	2	1/2"	150	225
4"	11-1/2"	10-3/4"	2"	1	1"	150	225
6"	14"	14"	4"	1	1"	150	225
8"	19-1/2"	17-1/4"	4"	2	1"	125	200
10"	24-1/2"	22-3/4"	4"	2	1"	100	150
12"	27-1/2"	24-3/4"	4"	2	1"	75	150
14"	31"	27-3/4"	4"	2	1"	75	150
16"	34"	31-1/4"	4"	2	1"	50	150
18"	38-1/2"	35"	6"	2	1"	50	125
20"	40"	42-3/4"	6"	2	1"	50	125
24"	51"	45-1/2"	6"	2	1"	25	125
30"	60"	66"	6"	2	1"	25	50
36"	77"	77"	6"	2	1"	25	50
42"	80"	90"	6"	2	1"	25	50
48"	90"	102"	6"	2	1"	25	50

\* Uses Type A body style. See page 7.  
 For larger sizes up to 96", consult factory.

# Tideflex® Coarse Bubble Diffuser

- ▶ Excellent oxygen transfer and mixing characteristics
- ▶ Provides long-term, maintenance-free service life
- ▶ Provides absolute backflow prevention
- ▶ Prevents clogging and fouling - no jet wash or acid baths required
- ▶ Durable, heavy-duty construction



## Materials of Construction

- ▶ Neoprene, Buna-N, EPDM and Viton®
- ▶ 304/316 stainless steel clamp
- ▶ PVC mounting bushings
- ▶ 304/316 stainless steel NPT connection

## Coarse Bubble Diffuser

Flow Range A - 0-6 SCFM  
Flow Range B - 0-12 SCFM  
Flow Range C - 0-24 SCFM

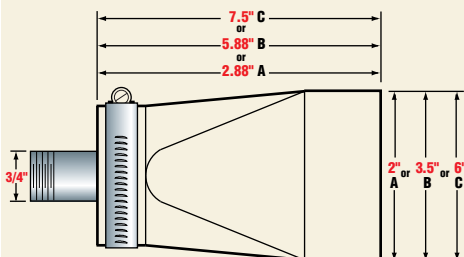

Air Diffuser brochure and binder available, featuring coarse bubble, fine bubble and combined diffuser systems.

Providing optimal oxygen transfer and mixing characteristics with absolute backflow prevention, Red Valve's Tideflex® Air Diffusers are ideal for use in municipal and industrial aeration applications. While conventional coarse bubble diffusers typically clog with sludge when airflow is interrupted due to blower shutdown or power failure, Red Valve's Tideflex® Coarse Bubble Diffusers maximize mixing while totally isolating the wastewater from the air manifold and related equipment and instrumentation. By allowing routine shutdowns and eliminating the need to run blowers or compressors around the clock to prevent clogging of the diffusers and manifold, Tideflex® Diffusers provide substantial savings in energy and operational costs.

The principle of operations is simple - positive differential air pressure opens the Tideflex® Diffuser, allowing airflow. Reserve pressure on the outside of the diffuser seals the bill, preventing backflow of solids or liquids. The patented elastomeric design closes drop-tight, even sealing around entrapped solids, eliminating any concern of clogging commonly associated with conventional air diffuser systems - as well as the extensive costs required to maintain, repair and clean them.

Featuring a flexible, all elastomer, non-fouling construction, Tideflex® Coarse Bubble Diffusers are maintenance free and custom built to your exact requirements. To suit your specific diffuser project and installation needs, Tideflex® Diffusers are available in various elastomers.

Red Valve not only supplies diffusers, but can design complete air diffuser packages for new and retrofitted systems. These packages include drop legs, manifolds, headers, supports and all equipment within the tank.

The correct sizing of manifolds and headers and the proper configuration of piping and diffusers are important in order to ensure the successful installation and operation of the system. Red Valve combines years of experience with superior diffusers to supply the most cost-effective and efficient systems for industrial and municipal applications.

Available with 1/2" or 3/4" thread connectors or a slip-on connection, TF-A Air Diffusers are ideal for new and retrofit systems.



# Redflex® Expansion Joints & Rubber

- ▶ Expansion Joints
- ▶ Single or Multiple Arch
- ▶ Ducting Joints
- ▶ Reducing Joints
- ▶ Rubber Reducers
- ▶ Rubber Elbows
- ▶ Rubber Fittings
- ▶ Rubber Pipe
- ▶ Vibration Pipe
- ▶ Flanged or Slip On
- ▶ Teflon® Lined
- ▶ “Smart” Technology
- ▶ Custom Fabricated
- ▶ Sizes 1" to 108"



22

Redflex® Expansion Joints and Rubber Products are designed to alleviate piping stress, noise and vibration, permit axial compression and elongation and compensate for lateral and angular movements. Constructed from non-corrosive and abrasion-resistant elastomers, Redflex® Expansion Joints and Rubber Products offer long-term, maintenance-free performance. Joints are available with filled arches or wide, shallow arches for slurry service. Redflex® Expansion Joints and Rubber Products are available with custom offsets, flanges and face-to-face lengths to meet individual design considerations.



## Standard J-1 Joint

- ▶ Single open arch
- ▶ Full face flanges
- ▶ ANSI 125 flanges
- ▶ Steel wire reinforcing
- ▶ Fabric reinforcing
- ▶ Split retaining rings
- ▶ Optional control rods

## Sewage Treatment

Redflex® Rubber Products are used throughout the wastewater treatment process and make up one of the most widely used product lines in sewage treatment plants around the world.

- ▶ Aeration
- ▶ Odor Control
- ▶ Raw Sewage
- ▶ Grit Removal
- ▶ Blowers
- ▶ Sludge Pumps
- ▶ Centrifugal Pumps
- ▶ Activated Sludge





# r Products

## Power Generation

Whether a plant is coal fired, combined cycle, or co-generation, power plants around the world use Redflex® Rubber Products on a wide range of applications.

- ▶ Scrubber Systems
- ▶ Cooling Water
- ▶ Pumps
- ▶ Ash Slurry
- ▶ Condenser-Turbine
- ▶ Connections
- ▶ I.D. and F.D. Fans
- ▶ Preheaters
- ▶ Precipitators



### Types of Movement

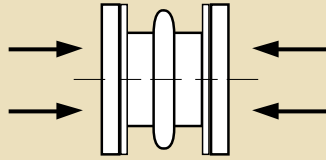

*Axial Compression*

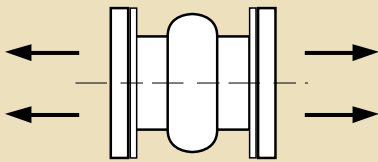

*Axial Extension*

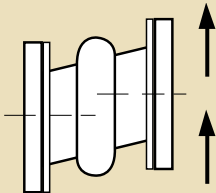

*Lateral Deflection*

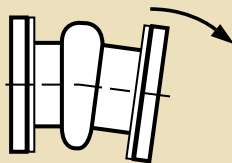

*Angular Movement*

## Marine

Redflex® Rubber Products are installed aboard many different types of marine vessels to absorb the transmission of vibration from pumps and blowers to increase operating efficiency.

- ▶ Unaffected by Saltwater Environment
- ▶ Reduce Electrolysis
- ▶ Reduce Maintenance
- ▶ Absorb Vibration



23

## Industrial

The durable, all-elastomer construction of Redflex® Expansion Joints and Rubber Fittings provides protection to industrial piping systems in the most demanding applications against movement, stress, abrasion and corrosion.

- ▶ Pulp and Paper Mills
- ▶ Chemical Processing
- ▶ Oil Refineries
- ▶ Leather Tanning
- ▶ Cement Production
- ▶ Food and Pharmaceutical



## HVAC

Redflex® Rubber Products are ideal for HVAC systems for use on chilled water lines, condenser piping, water chiller inlets and adjacent to compressors to stop the transmission of vibration.

- ▶ Schools
- ▶ Stores
- ▶ Hotels and Motels
- ▶ Commercial Office Buildings
- ▶ Hospitals
- ▶ Stadiums



*Redflex® brochure available, complete with technical information and dimensions.*

# Knife Gate Valves

- ▶ High quality, full-port valve
- ▶ Heavy-duty stainless steel gate
- ▶ Leak-proof, elastomer packing gland
- ▶ Pneumatic, electric, hydraulic or manual actuation



Red Valve manufactures quality knife gate valves in two distinct designs. The Red Valve Series G Knife Gate Valve features a cast iron body with stainless steel wetted parts. This efficient valve design affords the user a high-quality valve in which all the wetted parts (including the gate, seat, packing gland and flange face) are stainless steel while providing cost savings with cast iron flanges.

Red Valve's Series D Flexgate Knife Gate Valve features a heavy-duty, stainless steel gate and removeable rubber cartridge seats to provide a bi-directional seal and excellent wear resistance. This makes the Series D ideal for abrasive and corrosive slurries. The seats are all-metal-reinforced and available in a wide variety of elastomers for abrasion resistance and chemical compatibility.

24

## Materials of Construction - Series G

- ▶ Cast iron body lined with 316 stainless steel
- ▶ 316 metal seat or EPDM resilient seat
- ▶ Stainless steel gate

## Materials of Construction - Series D

- ▶ Cast iron body to 30"; fabricated steel 36"-72"  
Optional 304 SS or 316 SS body
- ▶ Gate ASTM A240 T-316  
Optional 17-4 pH
- ▶ Slurry sleeves available in Pure Gum Rubber, BUNA-N, EPDM and Viton®



## Series G

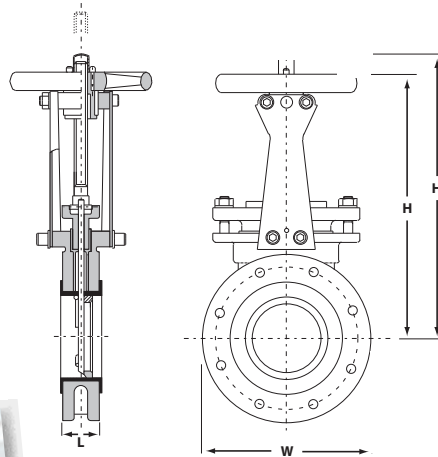

## Series D

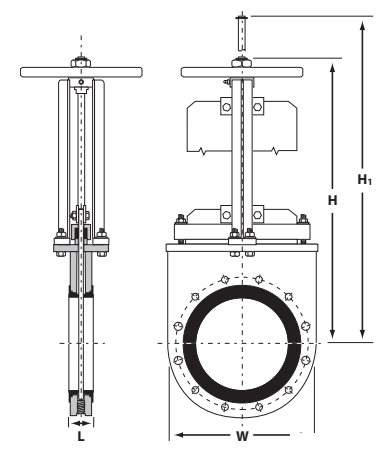

Knife Gate product brochure available.

## Knife Gates

VALVE SIZE	SERIES G				SERIES D				MAX WORKING PRESSURE PSI
	LENGTH L	WIDTH W	HEIGHT		LENGTH L	WIDTH W	HEIGHT		
			CLOSED H	OPEN H <sub>1</sub>			CLOSED H	OPEN H <sub>1</sub>	
2"	1-7/8"	6-1/2"	12"	14"	-	-	-	-	150
2-1/2"	1-7/8"	6-1/2"	11"	13"	-	-	-	-	150
3"	2"	8"	13"	15"	2"	8"	17-1/8"	20-3/8"	150
4"	2"	8"	14"	17"	2"	9-1/4"	18-1/4"	22-5/8"	150
5"	2-1/4"	10"	16"	20"	-	-	-	-	150
6"	2-1/4"	11-1/4"	19"	25"	2-1/4"	11-1/4"	21-1/16"	27-3/16"	150
8"	2-3/4"	13-1/2"	23"	31"	2-3/4"	14"	26-9/16"	34-9/16"	150
10"	2-3/4"	16"	27"	37"	2-3/4"	16-3/4"	32-7/16"	43-5/8"	150
12"	3"	19"	32"	43"	3"	20-1/8"	37"	50-7/8"	*100
14"	3"	21"	35"	48"	3"	21-1/2"	43-5/8"	57-1/8"	*100
16"	3-1/2"	23-1/2"	39"	54"	3-1/2"	24"	47-1/2"	63"	*100
18"	3-1/2"	25"	43"	59"	3-1/2"	25-3/4"	52-5/8"	70"	*100
20"	4-1/2"	27-1/2"	49"	67"	4-1/2"	27-1/2"	57-15/16"	74-1/8"	*100
24"	4-1/2"	32"	58"	78"	4-1/2"	32-1/2"	66-11/16"	86-15/16"	*100
30"	6"	38-3/4"	75"	111"	5"	38-3/4"	88-5/8"	120-5/8"	*75
36"	7"	46"	90"	132"	5-1/8"	46"	96"	134-7/8"	*75

\*Contact factory for higher working pressures.

For larger sizes up to 72", consult factory.

# Pressure Sensors

- ▶ Protects and isolates instrumentation
- ▶ Full 360° pressure reading
- ▶ Self-cleaning, flexing action
- ▶ Will not clog like traditional diaphragm seals
- ▶ Excellent pump protection
- ▶ Accuracy of  $\pm 2\%$  of installed instrument



## Materials of Construction

- ▶ Carbon steel, stainless steel or PVC body
- ▶ Sleeves available in Pure Gum Rubber, Neoprene, Hypalon®, Chlorobutyl, Buna-N, EPDM and Viton®
- ▶ ANSI Class 150, 300 and 600 available
- ▶ Optional food grade Ladish Tri-Clamp



Pressure Sensor brochure available.

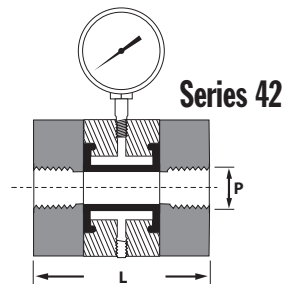

## Series 42

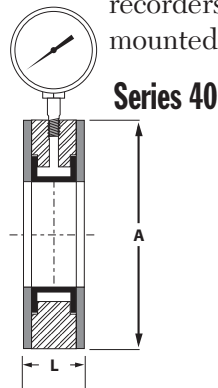

Red Valve Pressure Sensors are the industry standard for protecting instrumentation and assuring accurate, dependable pressure measurement of slurry and corrosive fluids.

The line pressure is sensed 360° through the flexible rubber sleeve. The captive fluid is displaced through the pressure sensor body to the instrument's Bourdon tube. All instruments are isolated and protected from the process, assuring positive and accurate readings.

The full-faced, thru-bolted Series 40 installs directly inline. For small-diameter, threaded-end pipe, the Series 42 is available in sizes 1/2" to 2". For large-diameter pipe, the wafer-style Series 48 is available in sizes 10" - 48".

The thru-bolted Series 40 can be mounted in any flow direction, submerged in a tank or mounted with a blind flange as a dead end to monitor tank levels.

The Red Valve standard gauge is bottom mounted with a 2-1/2" diameter steel case; accuracy of this gauge is  $\pm 2\%$  of the installed instrument. A gauge having a 0-100 psi range is furnished as standard unless otherwise specified. Gauges covering 0-60 and 0-200 psi are optional at no additional cost. All Red Valve Pressure Sensors and gauges are tested and calibrated to assure the highest level of accuracy.

Other ranges of pressure gauges, transmitters, transducers, recorders, differential pressure or vacuum switches can be mounted to the Series 40, Series 42 and Series 48.

## Series 40

NPT SIZE P	LENGTH L	WORKING PRESSURE AT 100°F psi*	WEIGHT lbs*
1/2"	2-7/8"	720	5
1"	3-3/8"	720	6
1-1/2"	3-3/8"	720	15
2"	3-3/8"	720	20

\* PVC units have working pressures of 200 psi.

ANSI FLANGE SIZE	OUTSIDE DIAMETER A	LENGTH L	WORKING PRESSURE AT 100°F psi*	WEIGHT lbs*
1"	4-1/2"	1-7/8"	275	6
1-1/2"	5"	1-7/8"	275	8
2"	6"	1-7/8"	275	12
2-1/2"	7"	1-7/8"	275	16
3"	7-1/2"	1-7/8"	275	18
4"	9"	2-1/8"	275	27
5"	10"	2-1/4"	275	32
6"	11"	2-1/4"	275	37
8"	13-1/2"	2-1/2"	275	58

\*Sizes 10" - 36" have a wafer design.

# Applications

Since 1953, Red Valve's quality products have been solving the world's toughest flow control problems. With our wide range of manual pinch valves, control valves, Tideflex® Check Valves, Redflex® Expansion Joints, Tideflex® Air Diffusers, Flexgate Knife Gate Valves and non-clogging pressure sensors, Red Valve has become the leading provider of valves and related products for municipal and industrial applications worldwide.

## Wastewater Treatment Plants

Accurate, repeatable linear flow control and drop-tight, bi-directional shutoff make Red Valve ideal for these demanding wastewater treatment application:

- ▶ **Sludge Control**
- ▶ **Raw Sewage Control**
- ▶ **Flow Equalization**
- ▶ **Lime Control**
- ▶ **Polymer Feed Systems**
- ▶ **Grit Systems**



26

## Mining Industry

The rugged construction of Red Valve products has made them the valves of choice on tough, abrasive mining slurries. Their simple, maintenance-free designs allow them to operate reliably in harsh conditions:

- ▶ **Tailings**
- ▶ **Flotation Column Cell**
- ▶ **Centrifuge Control**
- ▶ **Lime Feed Systems**
- ▶ **Coal Washing**
- ▶ **Solids Separation**



# Pulp and Paper Mills

Pulp stock, coating and recycled paper lines are some of the more difficult valve applications found in pulp and paper mills. The flexible elastomer sleeves of Red Valve Pinch Valves are custom fabricated to withstand these abrasive services:

- ▶ Cyclone Discharge
- ▶ Recycled Paper
- ▶ Pulp Stock
- ▶ Coatings
- ▶ pH Addition
- ▶ Lime Mud
- ▶ De-inking



# Power Industry

Lime and ash handling are two tough services in a power plant, and the abrasion-resistant and self-cleaning flexible elastomer sleeves of Red Valve Pinch Valves won't scale, bridge, plug or freeze on slurries:

- ▶ Thickener Underflow
- ▶ Wet Lime Scrubbers
- ▶ FGD Systems
- ▶ Ash Handling
- ▶ Coal Handling
- ▶ Bottom Ash



# Chemical Industry

Red Valve products have no packing to maintain and no cavities, seats or cam action to bind valve operation. Chemical plants use Red Valve products for many corrosive chemical applications:

- ▶ Slurry/Chemicals
- ▶ Titanium Dioxide
- ▶ Catalyst Feed Systems
- ▶ Industrial Treatment
- ▶ Emulsive Chemicals
- ▶ Powders



27

# CSO/SSO Systems

The elastomer duckbill design and passive operation of the Tideflex Check Valve provide long-term, reliable backflow prevention for:

- ▶ Pump Houses
- ▶ Lift Stations
- ▶ Effluent Diffuser Systems
- ▶ Floatables Control



# General Industry

Red Valve products are frequently specified as original equipment by manufacturers of industrial process systems:

- ▶ Pneumatic Conveying
- ▶ Tobacco Plants
- ▶ Refineries
- ▶ Dye Plants
- ▶ Food and Beverage Plants
- ▶ Cement, Sand, Silica
- ▶ Scrubbing





Valve Company, Inc.

600 N. Bell Avenue  
Building 2  
Carnegie, PA 15106

PHONE:  
412/279-0044

FAX:  
412/279-7878

[www.redvalve.com](http://www.redvalve.com)

The information presented in this catalog is provided in good faith. Red Valve Company, Inc., reserves the right to modify or improve its design specifications without notice and does not imply any guarantee or warranty for any of its products from reliance upon the information contained herein. All orders are subject to Red Valve's standard terms and warranty and are subject to final acceptance by Red Valve. Red Valve cannot be held responsible for typographical or printer's errors.

Viton and Hypalon are registered trademarks of DuPont Dow Elastomers. Teflon is a registered trademark of the DuPont Company. Redflex, Tideflex, Red Valve and the Red Valve "rv" logo are registered trademarks of Red Valve Company, Inc.

© Red Valve Company, 2001. All Rights Reserved. Red Valve is a registered trademark of Red Valve Company, Inc.



RECYCLABLE  
PAPER